



Lightech™ LED Driver

97758

LED DC 15W 700mA

901015700ELBD

LED Driver DC CC, Terminal Block

Current: DC

Availability: null

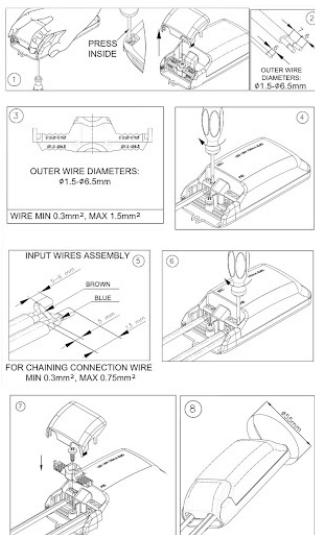
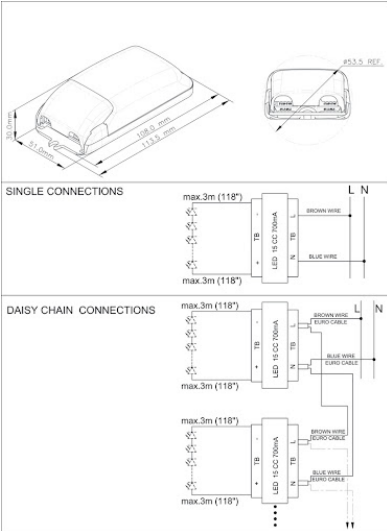

Notes:

- Specifications may vary without notice
- Always consult National, State and local electrical codes
- Parameters are measured at rated output, rated load and at an ambient temperature of 25°C
- Expect slight variation including component tolerance, setup tolerance, line regulation and load regulation
- Power supplies should always be stress tested and tested for EMC within specific fixtures
- Where grounding/earthing is not indicated, avoid grounding/earthing or contact with grounded/earthed metal enclosures
- Performance with dimmers, where supported, may vary depending on dimmer model
- Subject to limited warranty (3yr for transformers, 5yr for drivers) terms and conditions as published from time to time

Specs

Power: 15.0 W

Input specs

Power factor: 0.9
 Input current: 0.12-0.12 A
 Input frequency: 50 Hz
 Input voltage: 220.0-240.0 V
 Efficiency: 80 %

Output specs

Output current: 700.0 mA
 Output voltage range: 11.0-25.0 V

Dimmable

Dimmable: true

Protections

Over temperature protection: true
 Reinforced insulation: true
 Input voltage surge protection: true

Environment

Ta min: -25.0 °C
 IP : 20
 Ta max: 45.0 °C
 Tc: 75.0 °C
 Storage temp.: -10...70 °C

Standards

CE: true
 SELV: true

Mechanical

Case color: white
 Weight: 0.086 kg
 Case material: Plastic